

SYSTEM TOP 100

A 15 – C 250 with galv. steel frame and slot grating – low profile



Product range

Article	Article No. A15		Article No. C 250		Construction length mm	Construction depth (mm)		Pieces per pallet	
	Weight kg	Weight kg	Weight kg	Inlet		Outlet			
	6321000...		6343000...						
Basic element with outlet *	80	...00080	20,0	...00080	22,2	1000	80	80	24
		...70080	20,0	...70080	22,2	1000	80	80	24
		...50080	10,0	...50080	11,1	500	80	80	48
Basic element with outlet *	100	...00100	24,9	...00100	27,1	1000	100	100	24
		...70100	24,9	...70100	27,1	1000	100	100	24
		...50100	12,5	...50100	13,5	500	100	100	48
Basic element with outlet *	120	...00120	26,6	...00120	28,8	1000	120	120	24
		...70120	26,6	...70120	28,8	1000	120	120	24
		...50120	13,3	...50120	14,4	500	120	120	48



with slot grating

* with vertical outlet DN 100

Waterway 360 cm²/m, slot grating

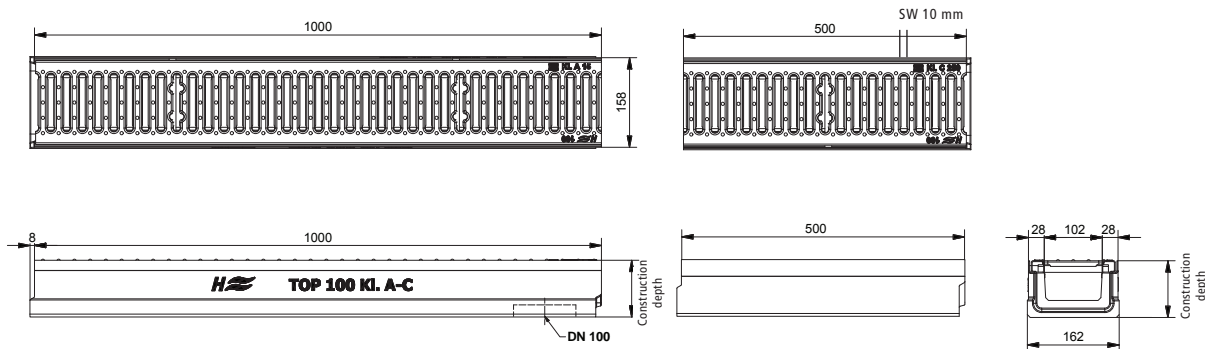

Accessories for TOP 100

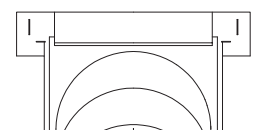

End piece

Art.No.: 7001110080 Construction depth 80
 Art.No.: 7001110100 Construction depth 100
 Art.No.: 7001110120 Construction depth 120

See page 108 for more Accessories

Supplied By:
TRENCHDRAIN SUPPLY
 877-903-7246
 www.trenchdrainsupply.com

SYSTEM TOP 100

A 15 – C 250 with galv. steel frame/mesh grating – low profile



Product range

Article	Article-No. C 250	Weight kg	Construction length mm	Construction depth (mm) Inlet	Construction depth (mm) Outlet	Pieces per pallet	
6333000...							
Basic element with outlet *	80	...00080	22,3	1000	80	80	24
		...70080	21,8	1000	80	80	24
		...50080	11,2	500	80	80	48
Basic element with outlet *	100	...00100	27,1	1000	100	100	24
		...70100	26,6	1000	100	100	24
		...50100	13,6	500	100	100	48
Basic element with outlet *	120	...00120	28,9	1000	120	120	24
		...70120	28,4	1000	120	120	24
		...50120	14,5	500	120	120	48



* with vertical outlet DN 100

Waterway 900 cm²/m - mesh 30/10 grating

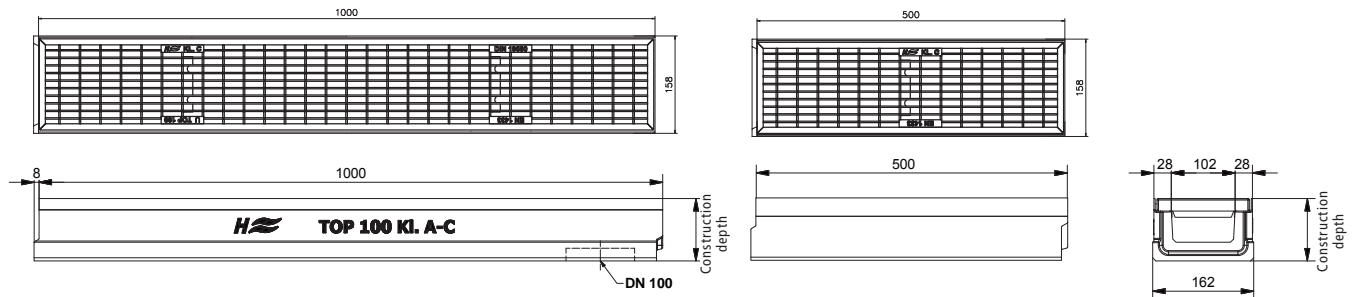

with mesh grating 30/10

Accessories for TOP 100

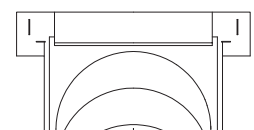

End piece

Art.No.: 7001110080 Construction depth 80
 Art.No.: 7001110100 Construction depth 100
 Art.No.: 7001110120 Construction depth 120

See page 108 for more Accessories

SYSTEM TOP 100

C 250 with galv. steel frame and grating – low profile



Product range

Article	Article-No. A15 - C250	Weight kg	Construction length mm	Construction depth (mm) Inlet	Construction depth (mm) Outlet	Pieces per pallet	
6313000...							
Basic element with outlet *	80	...00080	25,5	1000	80	80	24
		...70080	25,0	1000	80	80	24
		...50080	12,8	500	80	80	48
Basic element with outlet *	100	...00100	30,4	1000	100	100	24
		...70100	29,9	1000	100	100	24
		...50100	15,2	500	100	100	48
Basic element with outlet *	120	...00120	32,1	1000	120	120	24
		...70120	32,6	1000	120	120	24
		...50120	16,1	500	120	120	48



Cast iron grating

* with vertical outlet DN 100

Water way 564 cm²/m, drainage channel with 2 ductile iron gratings

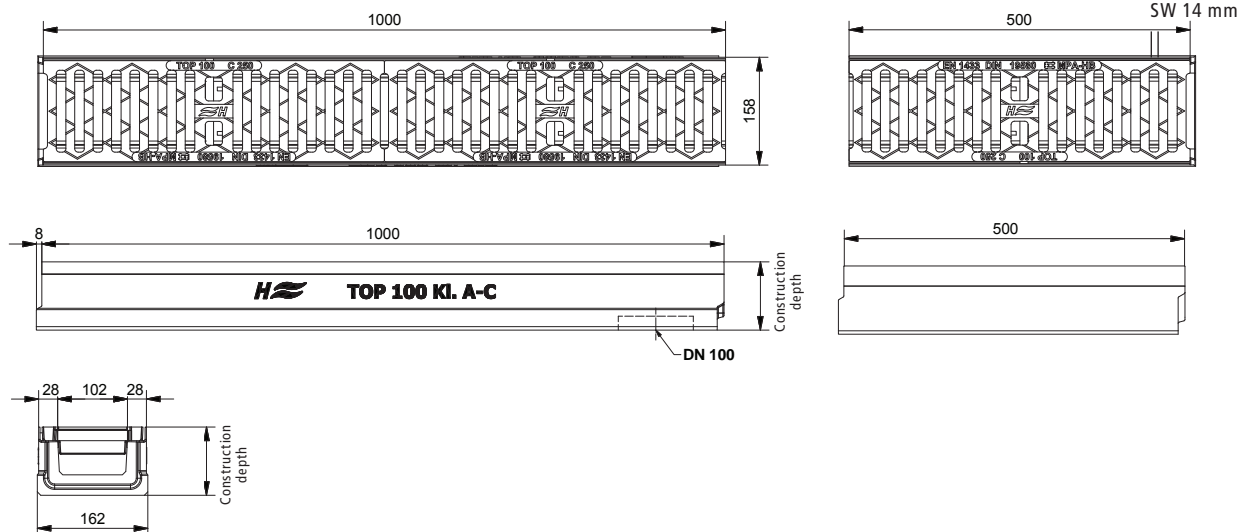

Accessories for TOP 100

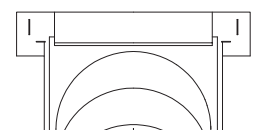

End piece

Art.No.: 7001110080 Construction depth 80
 Art.No.: 7001110100 Construction depth 100
 Art.No.: 7001110120 Construction depth 120

See page 108 for more Accessories

Supplied By:

**TRENCHDRAIN
SUPPLY**

877-903-7246

www.trenchdrainsupply.com

SYSTEM MAXI 100

C 250 with iron edge protection and grating – low profile



Product range

Article	Article-No. C250	Weight kg	Construction length mm	Construction depth (mm) Inlet	Construction depth (mm) Outlet	Pieces per pallet	
6113100...							
Basic element with outlet *	80	...00080	30,5	1000	80	80	24
		...70080	30,0	1000	80	80	24
		...50080	15,3	500	80	80	48
Basic element with outlet *	100	...00100	34,3	1000	100	100	24
		...70100	33,8	1000	100	100	24
		...50100	17,2	500	100	100	48
Basic element with outlet *	120	...00120	35,5	1000	120	120	24
		...70120	35,0	1000	120	120	24
		...50120	17,8	500	120	120	48



Ductile iron grating with cross slots

* with vertical outlet DN 100

also available with pedestrian grating!

Waterway 554 cm²/m, Channel element with 2 gratings

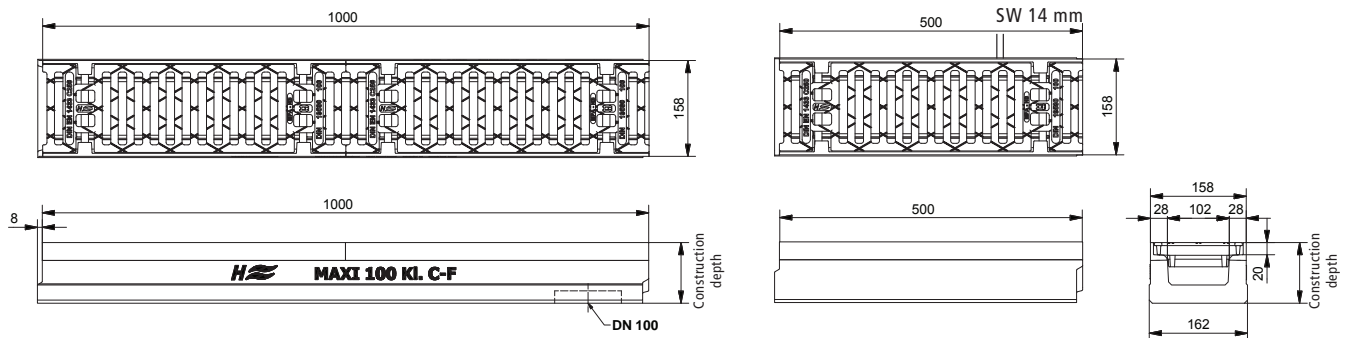

Accessories for MAXI 100

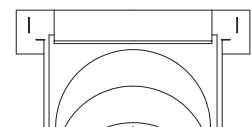

End piece

Art.No.: 7001110080 Construction depth 80
 Art.No.: 7001110100 Construction depth 100
 Art.No.: 7001110120 Construction depth 120

See page 108 for more Accessories

SYSTEM MAXI 100

D 400 / F 900 with edge protection and grating – low profile



Product range

Article	Article No. D 400	Weight kg	Article No. F 900	Weight kg	Construction depth (mm)		Pieces per pallet		
					Inlet	Outlet			
	6114000...		6116000...						
Basic element with outlet *	80	...00080	33,1	...00080	36,3	1000	80	80	24
		...70080	32,6	...70080	36,3	1000	80	80	24
		...50080	16,5	...50080	18,2	500	80	80	48
Basic element with outlet *	100	...00100	36,9	...00100	40,1	1000	100	100	24
		...70100	36,4	...70100	40,1	1000	100	100	24
		...50100	18,5	...50100	20,1	500	100	100	48
Basic element with outlet *	120	...00120	38,1	...00120	41,3	1000	120	120	24
		...70120	37,6	...70120	41,3	1000	120	120	24
		...50120	19,1	...50120	20,7	500	120	100	48



Ductile iron grating
with longitudinal slots

* with vertical outlet DN 100

also available with pedestrian grating!

Waterway 512 cm²/m, Channel element with 2 gratings

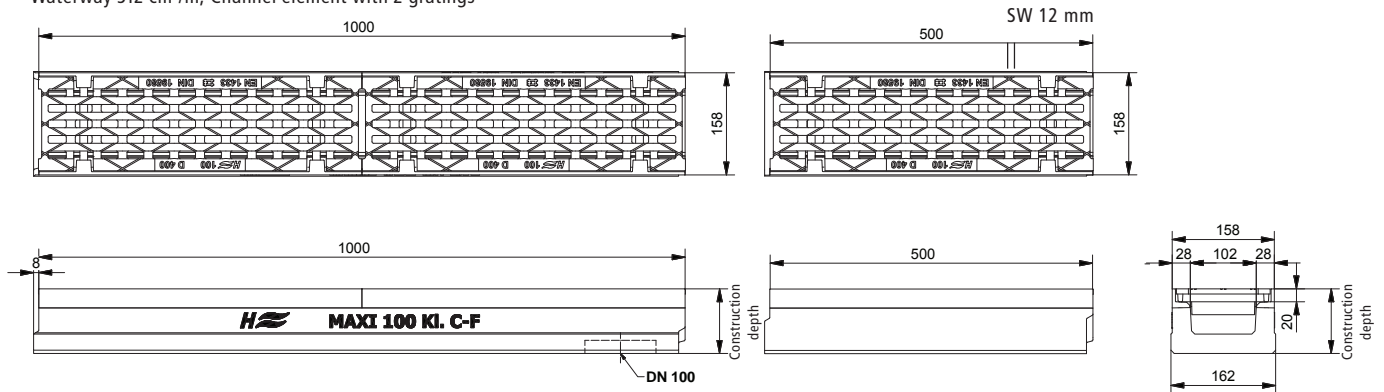

Accessories for MAXI 100

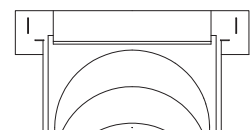

End piece

Art.No.: 7001110080 Construction depth 80
 Art.No.: 7001110100 Construction depth 100
 Art.No.: 7001110120 Construction depth 120

See page 108 for more Accessories

SYSTEM MAXI 100

E 600 with iron edge protection and iron grating – low profile



Product range

Article	Article No. E 600	Weight kg	Construction length mm	Construction depth (mm)		Pieces per pallet	
				Inlet	Outlet		
6215000...							
Basic element with outlet *	80	...00080	32,5	1000	80	80	24
		...70080	32,0	1000	80	80	48
		...50080	16,3	500	80	80	24
Basic element with outlet *	100	...00100	36,3	1000	100	100	24
		...70100	35,8	1000	100	100	24
		...50100	18,2	500	100	100	48
Basic element with outlet *	120	...00120	37,5	1000	120	120	24
		...70120	37,0	1000	120	120	24
		...50120	18,8	500	120	120	48



Ductile iron mesh grating

* with vertical outlet DN 100

Waterway 620 cm²/m, channel element with 2 gratings, SW 30/28 mm

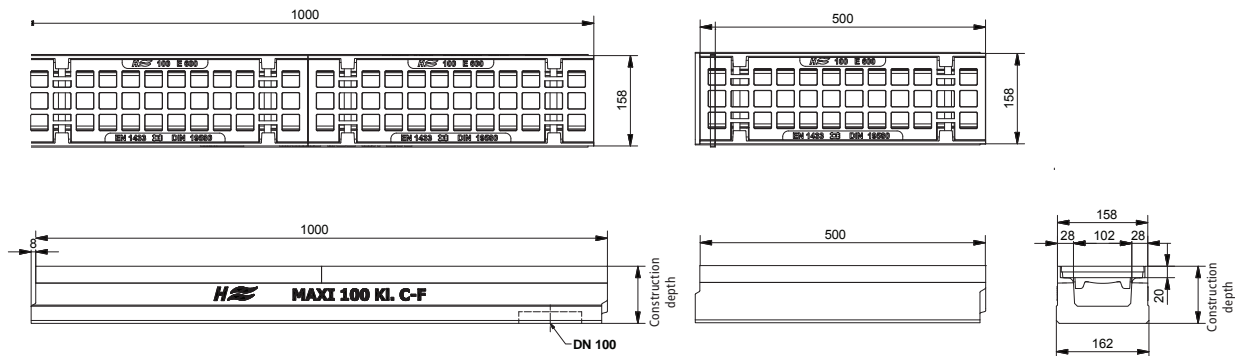

Accessories for MAXI 100

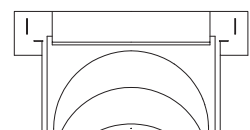

End piece

Art.No.: 7001110080 Construction depth 80
 Art.No.: 7001110100 Construction depth 100
 Art.No.: 7001110120 Construction depth 120

See page 108 for more Accessories

Supplied By:
**TRENCHDRAIN
 SUPPLY**
 877-903-7246
 www.trenchdrainsupply.com